

Außengewindestreihen External threading Filetage extérieur

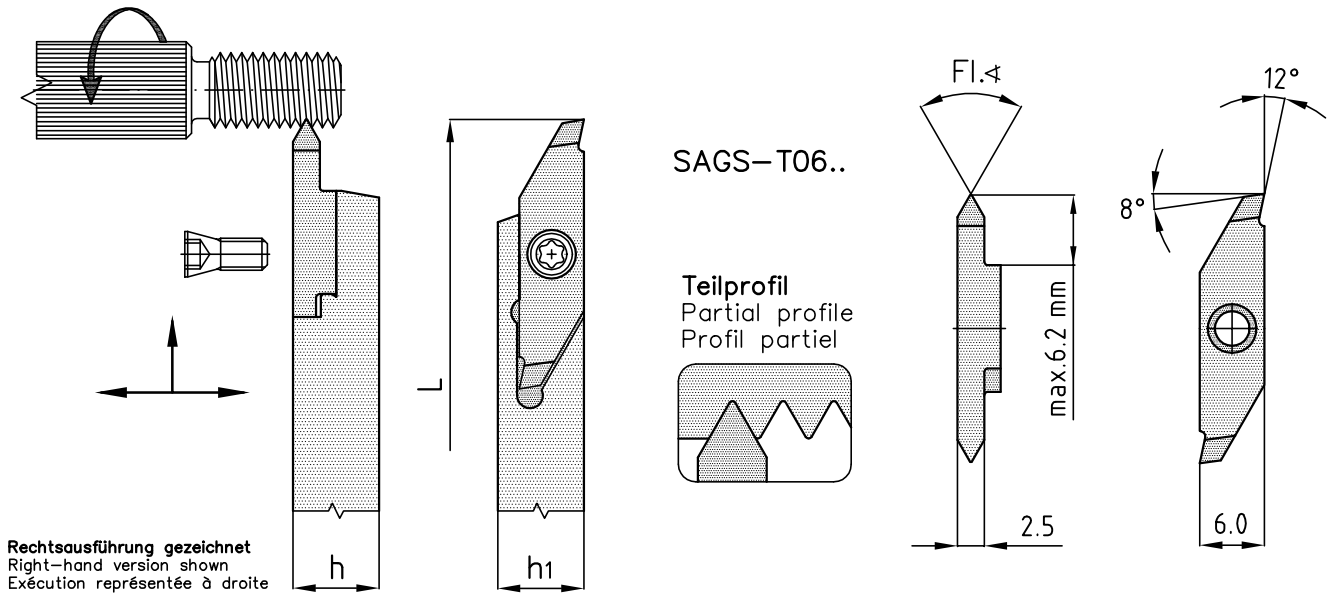

Rechtsausführung gezeichnet  
Right-hand version shown  
Exécution représentée à droite

Bestellbezeichnung Order number Désignation de commande



Seite Page 20

| Halter<br>Holder<br>Porte-outils | h  | h <sub>1</sub> | L   | Schraube<br>Screw<br>Vis | Schlüssel<br>Key<br>Clef |
|----------------------------------|----|----------------|-----|--------------------------|--------------------------|
| SSXA-T06-0808-L/R                | 8  | 8              | 140 | S3080-30°                | T8                       |
| SSXA-T06-1010-L/R                | 10 | 10             | 140 |                          |                          |
| SSXA-T06-1212-L/R                | 12 | 12             | 140 |                          |                          |
| SSXA-T06-1616-L/R                | 16 | 16             | 125 |                          |                          |

**Rechter Halter rechte Platte**  
Right-hand holder right-hand insert  
Porte-outil droite Plaquette droite

**Linker Halter linke Platte**  
Left-hand holder left-hand insert  
Porte-outil gauche Plaquette gauche

| Wendepplatten ISO Metrisch 60°<br>Indexable inserts ISO metric 60°<br>Plaquettes réversibles ISO métriques 60° | Beschichtet<br>Coated<br>Revêtu | Unbeschichtet<br>Uncoated<br>Non-rêvêtu | Type<br>Type<br>Type | Steigungsbereich mm<br>Range of pitch mm<br>Gamme de pas mm | Fl.4 |
|--|---------------------------------|---|----------------------|---|------|
| SAGS-T06-60°-T1-12°-L/R-G1A  | BD1                             |   | T1                   | 0.5-0.6-0.7-0.75-0.8  | 60°  |
| SAGS-T06-60°-T2-12°-L/R-G1A  | BD1                             |   | T2                   | 1.0-1.25-1.5  |      |
| SAGS-T06-60°-T3-12°-L/R-G1A  | BD1                             |   | T3                   | 1.75-2.0  |      |
| SAGS-T06-60°-T4-12°-L/R-G1A  | BD1                             |   | T4                   | 2.5-3.0   |      |

| Wendepplatten UN American Unified 60°<br>Indexable inserts UN American Unified 60°<br>Plaquettes réversibles UN American Unified 60° | Beschichtet<br>Coated<br>Revêtu | Unbeschichtet<br>Uncoated<br>Non-rêvêtu | Type<br>Type<br>Type | Gangzahl auf 1 Zoll<br>Number of threads per inch<br>Nombre de filets au pouce | Fl.4 |
|--|---------------------------------|---|----------------------|--|------|
| SAGS-T06-60°-T1-12°-L/R-G1A  | BD1                             |   | T1                   | 48-44-40-36-32   | 60°  |
| SAGS-T06-60°-T2-12°-L/R-G1A  | BD1                             |   | T2                   | 28-27-24-20  |      |
| SAGS-T06-60°-T3-12°-L/R-G1A  | BD1                             |   | T3                   | 18-16-14-13  |      |
| SAGS-T06-60°-T4-12°-L/R-G1A  | BD1                             |   | T4                   | 12-11.5-11-10-9  |      |

| Wendepplatten BSW Whitworth G°55°<br>Indexable inserts BSW Whitworth G°55°<br>Plaquettes réversibles BSW Whitworth G°55° | Beschichtet<br>Coated<br>Revêtu | Unbeschichtet<br>Uncoated<br>Non-rêvêtu | Type<br>Type<br>Type | Gangzahl auf 1 Zoll<br>Number of threads per inch<br>Nombre de filets au pouce | Fl.4 |
|--|---------------------------------|---|----------------------|--|------|
| SAGS-T06-55°-T6-12°-L/R-G1A  | BD1                             |   | T6                   | 72-60-56-48-40-36-32   | 55°  |
| SAGS-T06-55°-T7-12°-L/R-G1A  | BD1                             |   | T7                   | 28-26-24-22-20-19-18   |      |
| SAGS-T06-55°-T8-12°-L/R-G1A  | BD1                             |   | T8                   | 16-14-12-11-10-9   |      |

Außengewindestrehlen External threading Filetage extérieur

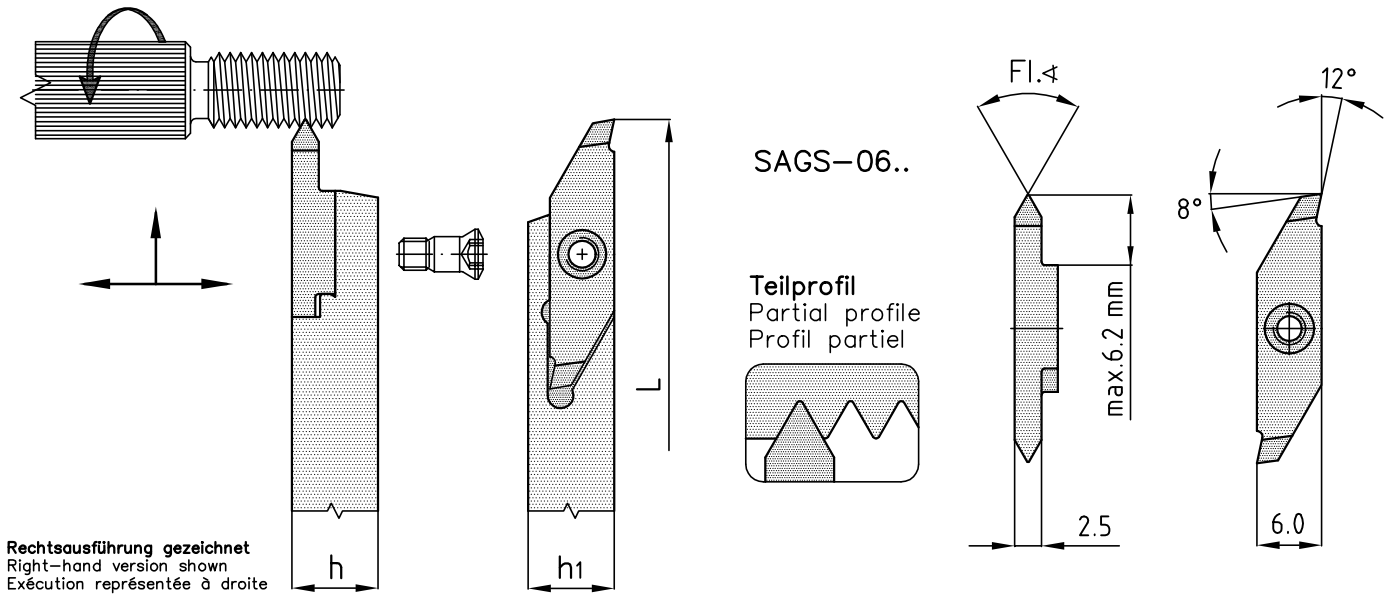

Bestellbezeichnung Order number Désignation de commande

| Halter<br>Holder<br>Porte-outils | h  | h1 | L   | Schraube<br>Screw<br>Vis | Schlüssel<br>Key<br>Clef |
|----------------------------------|----|----|-----|--------------------------|--------------------------|
| SSXA-06-0808-L/R                 | 8  | 8  | 140 |                          | T9                       |
| SSXA-06-1010-L/R                 | 10 | 10 | 140 |                          |                          |
| SSXA-06-1212-L/R                 | 12 | 12 | 140 |                          |                          |
| SSXA-06-1616-L/R                 | 16 | 16 | 125 |                          |                          |



Seite Page 20

**Rechter Halter rechte Platte**  
Right-hand holder right-hand insert  
Porte-outil droite Plaquette droite

**Linker Halter linke Platte**  
Left-hand holder left-hand insert  
Porte-outil gauche Plaquette gauche

| Wendeplatten ISO Metrisch 60°<br>Indexable inserts ISO metric 60°<br>Plaquettes réversibles ISO métriques 60° | Beschichtet<br>Coated<br>Revêtu | Unbeschichtet<br>Uncoated<br>Non-revêtu | Type<br>Type<br>Type | Steigungsbereich mm<br>Range of pitch mm<br>Gamme de pas mm | Fl. 4 |
|---|---------------------------------|---|----------------------|---|-------|
| SAGS-06-60°-T1-12°-L/R-G1A  | BD1                             |   | T1                   | 0.5-0.6-0.7-0.75-0.8  | 60°   |
| SAGS-06-60°-T2-12°-L/R-G1A  | BD1                             |   | T2                   | 1.0-1.25-1.5  |       |
| SAGS-06-60°-T3-12°-L/R-G1A  | BD1                             |   | T3                   | 1.75-2.0  |       |
| SAGS-06-60°-T4-12°-L/R-G1A  | BD1                             |   | T4                   | 2.5-3.0   |       |

| Wendeplatten UN American Unified 60°<br>Indexable inserts UN American Unified 60°<br>Plaquettes réversibles UN American Unified 60° | Beschichtet<br>Coated<br>Revêtu | Unbeschichtet<br>Uncoated<br>Non-revêtu | Type<br>Type<br>Type | Gangzahl auf 1 Zoll<br>Number of threads per inch<br>Nombre de filets au pouce | Fl. 4 |
|---|---------------------------------|---|----------------------|--|-------|
| SAGS-06-60°-T1-12°-L/R-G1A  | BD1                             |   | T1                   | 48-44-40-36-32   | 60°   |
| SAGS-06-60°-T2-12°-L/R-G1A  | BD1                             |   | T2                   | 28-27-24-20  |       |
| SAGS-06-60°-T3-12°-L/R-G1A  | BD1                             |   | T3                   | 18-16-14-13  |       |
| SAGS-06-60°-T4-12°-L/R-G1A  | BD1                             |   | T4                   | 12-11.5-11-10-9  |       |

| Wendeplatten BSW Whitworth G°55°<br>Indexable inserts BSW Whitworth G°55°<br>Plaquettes réversibles BSW Whitworth G°55° | Beschichtet<br>Coated<br>Revêtu | Unbeschichtet<br>Uncoated<br>Non-revêtu | Type<br>Type<br>Type | Gangzahl auf 1 Zoll<br>Number of threads per inch<br>Nombre de filets au pouce | Fl. 4 |
|---|---------------------------------|---|----------------------|--|-------|
| SAGS-06-55°-T6-12°-L/R-G1A  | BD1                             |   | T6                   | 72-60-56-48-40-36-32   | 55°   |
| SAGS-06-55°-T7-12°-L/R-G1A  | BD1                             |   | T7                   | 28-26-24-22-20-19-18   |       |
| SAGS-06-55°-T8-12°-L/R-G1A  | BD1                             |   | T8                   | 16-14-12-11-10-9   |       |

Außengewindestrehlen External threading Filetage extérieur

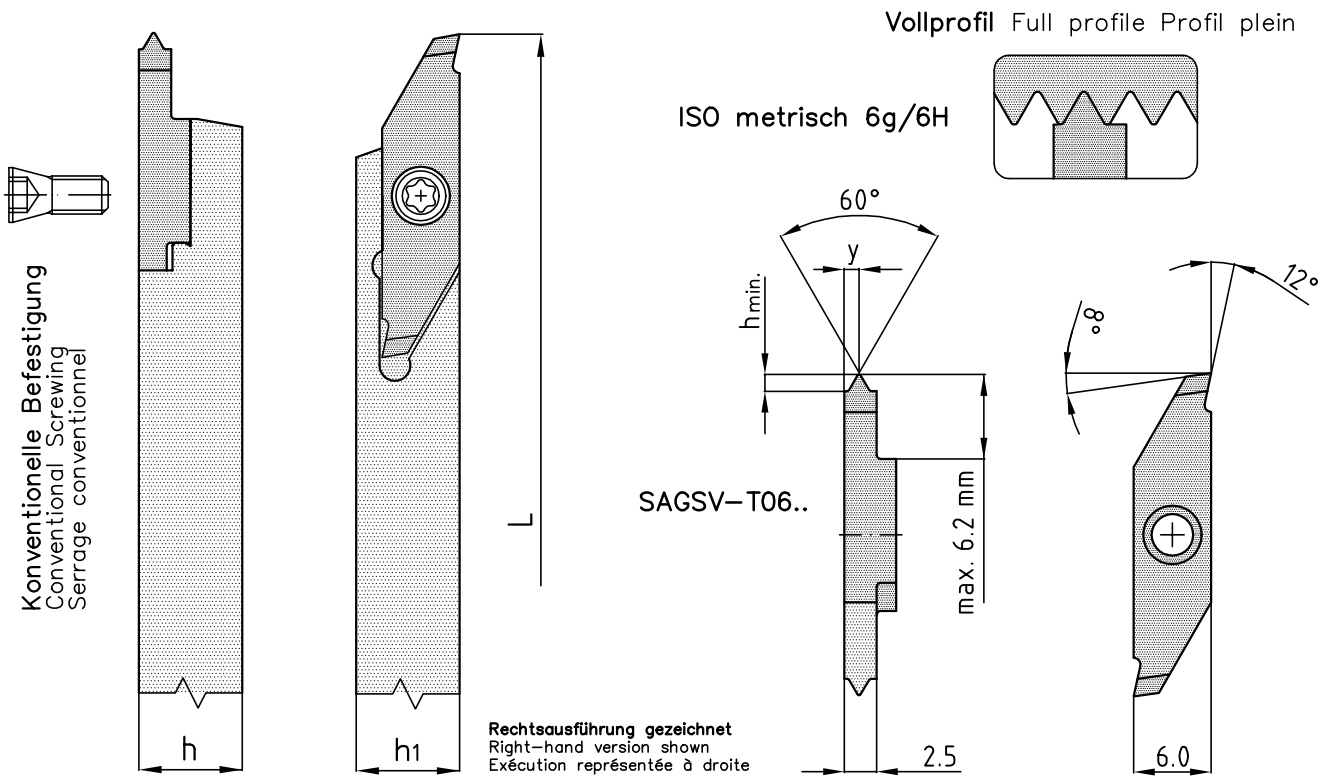

Bestellbezeichnung Order number Désignation de commande

| Halter<br>Holder<br>Porte-outils | h  | h1 | L   | Schraube<br>Screw<br>Vis | Schlüssel<br>Key<br>Clef |
|----------------------------------|----|----|-----|--------------------------|--------------------------|
| SSXA-T06-0808-L/R                | 8  | 8  | 140 | <br>S3080-30°            | <br>T8                   |
| SSXA-T06-1010-L/R                | 10 | 10 | 140 |                          |                          |
| SSXA-T06-1212-L/R                | 12 | 12 | 140 |                          |                          |
| SSXA-T06-1616-L/R                | 16 | 16 | 125 |                          |                          |

**Linker Halter linke Platte**  
Left-hand holder left-hand insert  
Porte-outil gauche Plaquette gauche

**Rechter Halter rechte Platte**  
Right-hand holder right-hand insert  
Porte-outil droite Plaquette droite

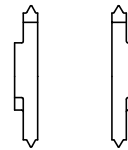

| Wendeplatten ISO Metrisch 60°<br>Indexable inserts ISO metric 60°<br>Plaquettes réversibles ISO métriques 60° | Beschichtet<br>Coated<br>Revêtu | Steigung mm<br>Pitch mm<br>Pas mm | h min. | y   | Links<br>Left<br>Gauche | Rechts<br>Right<br>Droite |  |
|---|---------------------------------|-----------------------------------|--------|-----|-------------------------|---------------------------|--|
| SAGSV-T06-60°-0.5-12°-L/R-G1A   | BD1                             | 0.5                               | 0.31   | 0.4 | ●                       | ●                         | ● ab Lager<br>ex stock<br>en magasin       |
| SAGSV-T06-60°-0.6-12°-L/R-G1A   | BD1                             | 0.6                               | 0.37   | 0.6 | ☎                       | ☎                         |  |
| SAGSV-T06-60°-0.7-12°-L/R-G1A   | BD1                             | 0.7                               | 0.43   | 0.6 | ☎                       | ●                         | ☎ auf Anfrage<br>on request<br>sur demande |
| SAGSV-T06-60°-0.75-12°-L/R-G1A  | BD1                             | 0.75                              | 0.46   | 0.6 | ☎                       | ●                         |  |
| SAGSV-T06-60°-0.8-12°-L/R-G1A   | BD1                             | 0.8                               | 0.49   | 0.6 | ☎                       | ●                         | ☎ auf Anfrage<br>on request<br>sur demande |
| SAGSV-T06-60°-1.0-12°-L/R-G1A   | BD1                             | 1.0                               | 0.61   | 0.7 | ●                       | ●                         |  |
| SAGSV-T06-60°-1.25-12°-L/R-G1A  | BD1                             | 1.25                              | 0.77   | 0.9 | ☎                       | ●                         | ☎ auf Anfrage<br>on request<br>sur demande |
| SAGSV-T06-60°-1.5-12°-L/R-G1A   | BD1                             | 1.5                               | 0.92   | 1.0 | ☎                       | ●                         |  |
| SAGSV-T06-60°-1.75-12°-L/R-G1A  | BD1                             | 1.75                              | 1.07   | 1.2 | ☎                       | ☎                         | ☎ auf Anfrage<br>on request<br>sur demande |
| SAGSV-T06-60°-2.0-12°-L/R-G1A   | BD1                             | 2.0                               | 1.23   | 1.3 | ☎                       | ☎                         |  |

Außengewindestrehlen External threading Filetage extérieur

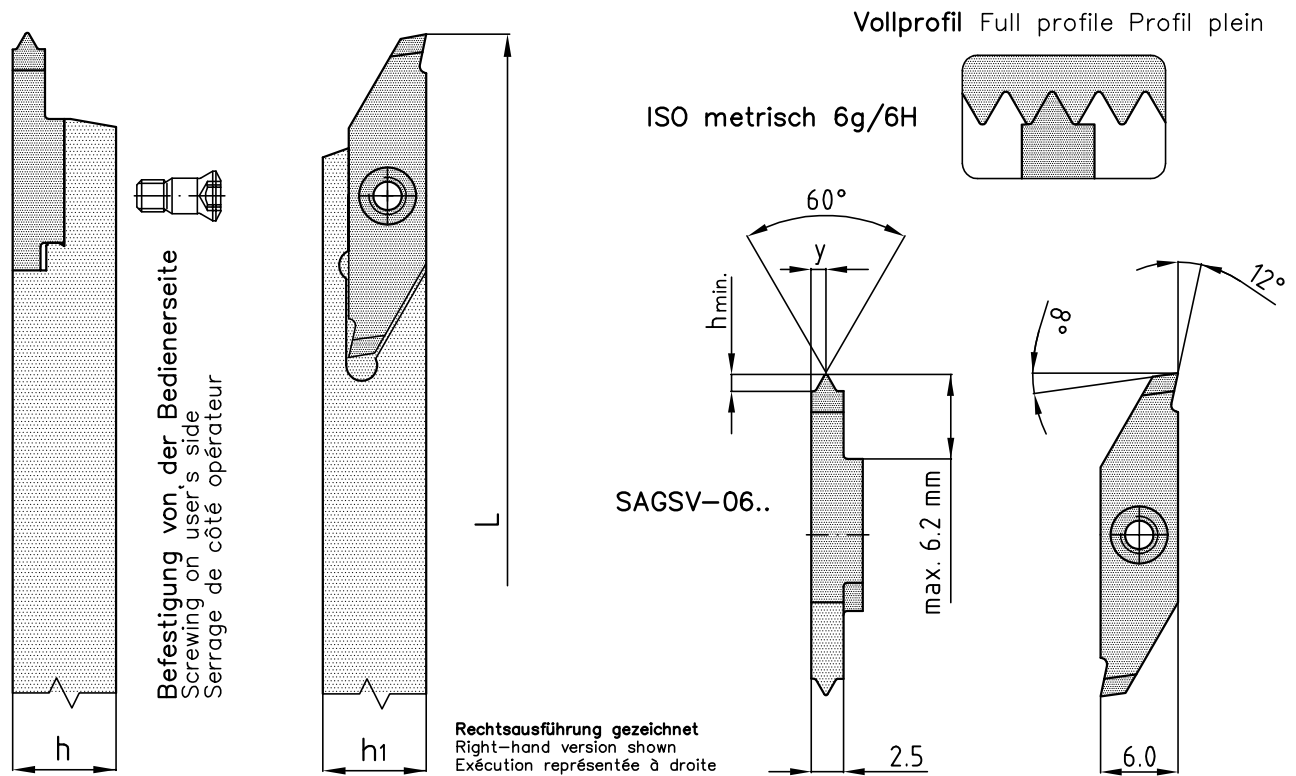



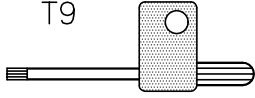





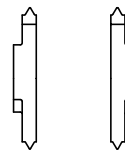















Bestellbezeichnung Order number Désignation de commande

| Halter<br>Holder<br>Porte-outils | h  | h1 | L   | Schraube<br>Screw<br>Vis  | Schlüssel<br>Key<br>Clef  |
|----------------------------------|----|----|-----|---|---|
| SSXA-06-0808-L/R                 | 8  | 8  | 140 | <br>S 3080 | T9  |
| SSXA-06-1010-L/R                 | 10 | 10 | 140 |   |   |
| SSXA-06-1212-L/R                 | 12 | 12 | 140 |   |   |
| SSXA-06-1616-L/R                 | 16 | 16 | 125 |   |   |

**Linker Halter linke Platte**  
Left-hand holder left-hand insert  
Porte-outil gauche Plaquette gauche

**Rechter Halter rechte Platte**  
Right-hand holder right-hand insert  
Porte-outil droite Plaquette droite



| Wendeplatten ISO Metrisch 60°<br>Indexable inserts ISO metric 60°<br>Plaquettes réversibles ISO métriques 60° | Beschichtet<br>Coated<br>Revêtu | Steigung mm<br>Pitch mm<br>Pas mm | h min. | y   | Links<br>Left<br>Gauche   | Rechts<br>Right<br>Droite   |   |
|---|---------------------------------|-----------------------------------|--------|-----|---|---|---|
| SAGSV-06-60°-0.5-12°-L/R-G1A  | BD1                             | 0.5                               | 0.31   | 0.4 |  |  |  ab Lager<br>ex stock<br>en magasin<br><br> auf Anfrage<br>on request<br>sur demande<br><br> |
| SAGSV-06-60°-0.6-12°-L/R-G1A  | BD1                             | 0.6                               | 0.37   | 0.6 |  |  |   |
| SAGSV-06-60°-0.7-12°-L/R-G1A  | BD1                             | 0.7                               | 0.43   | 0.6 |  |  |   |
| SAGSV-06-60°-0.75-12°-L/R-G1A   | BD1                             | 0.75                              | 0.46   | 0.6 |  |  |   |
| SAGSV-06-60°-0.8-12°-L/R-G1A  | BD1                             | 0.8                               | 0.49   | 0.6 |  |  |   |
| SAGSV-06-60°-1.0-12°-L/R-G1A  | BD1                             | 1.0                               | 0.61   | 0.7 |  |  |   |
| SAGSV-06-60°-1.25-12°-L/R-G1A   | BD1                             | 1.25                              | 0.77   | 0.9 |  |  |   |
| SAGSV-06-60°-1.5-12°-L/R-G1A  | BD1                             | 1.5                               | 0.92   | 1.0 |  |  |   |
| SAGSV-06-60°-1.75-12°-L/R-G1A   | BD1                             | 1.75                              | 1.07   | 1.2 |  |  |   |
| SAGSV-06-60°-2.0-12°-L/R-G1A  | BD1                             | 2.0                               | 1.23   | 1.3 |  |  |   |